

HRT210 Machine Layout Drawing

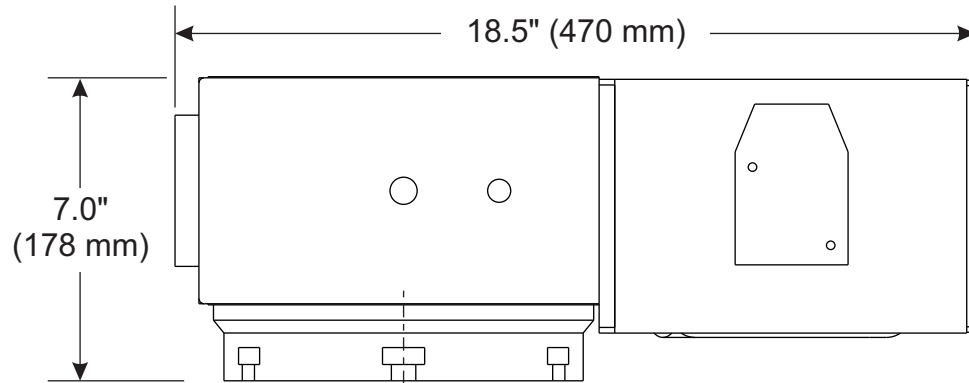

Top View

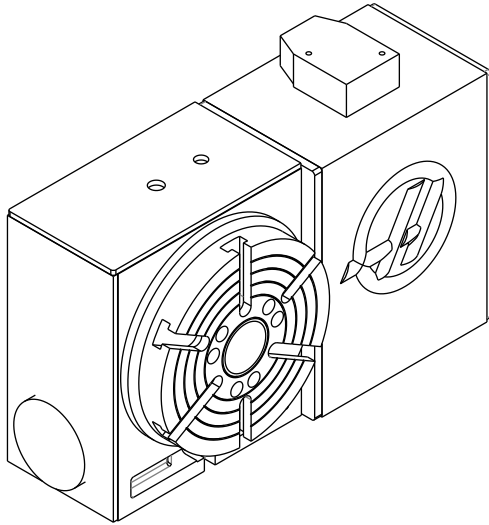
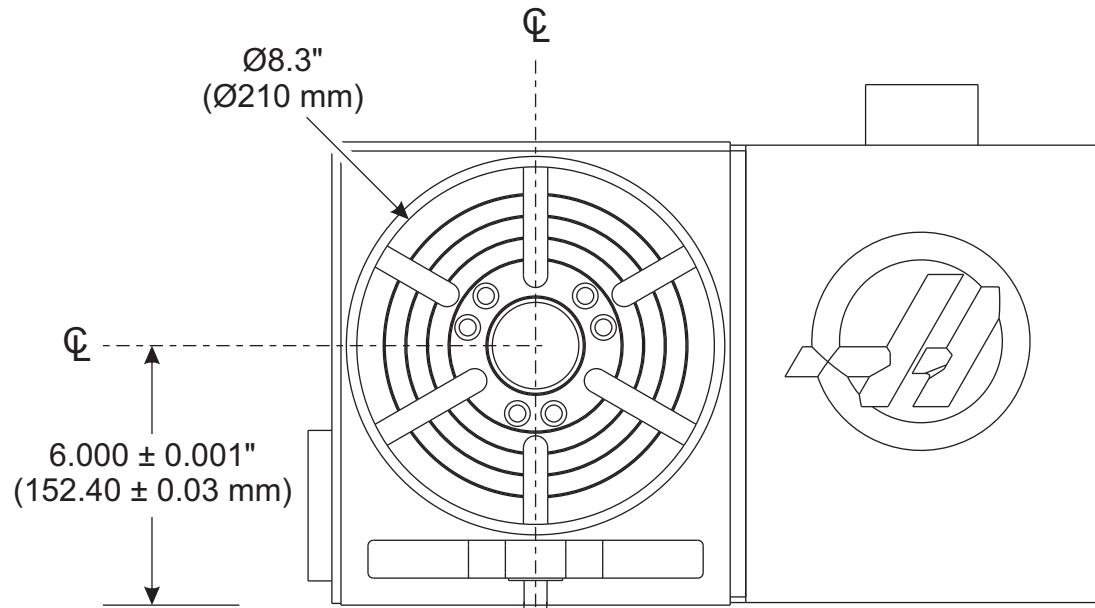
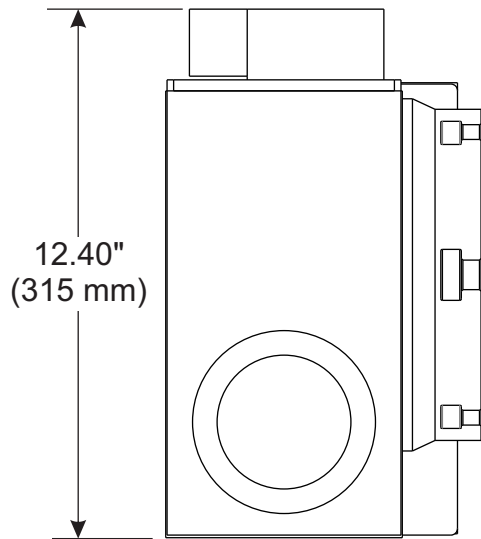

Front View



HRT210 Machine Layout Drawing

HRT210 Platter Dimensions

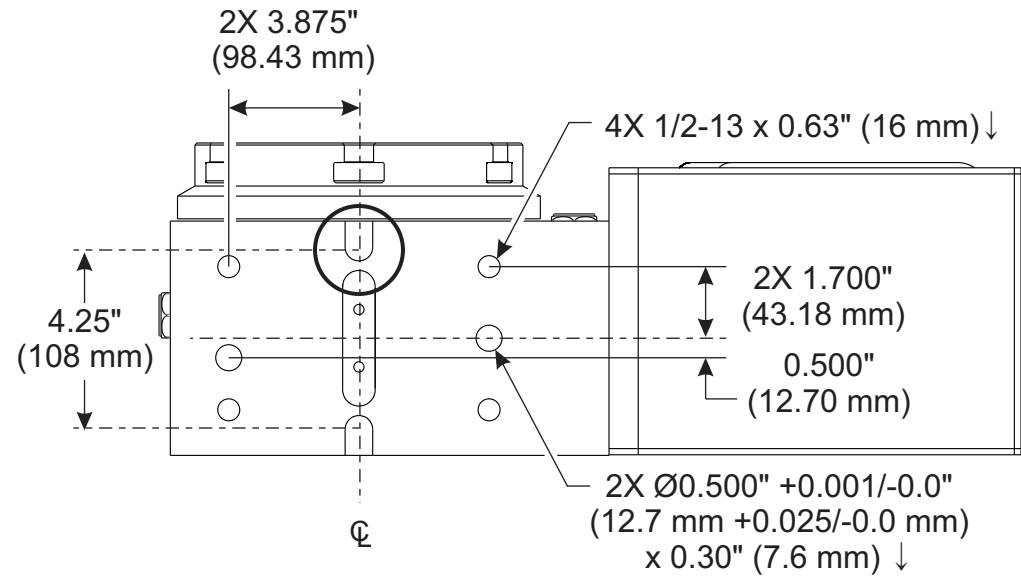
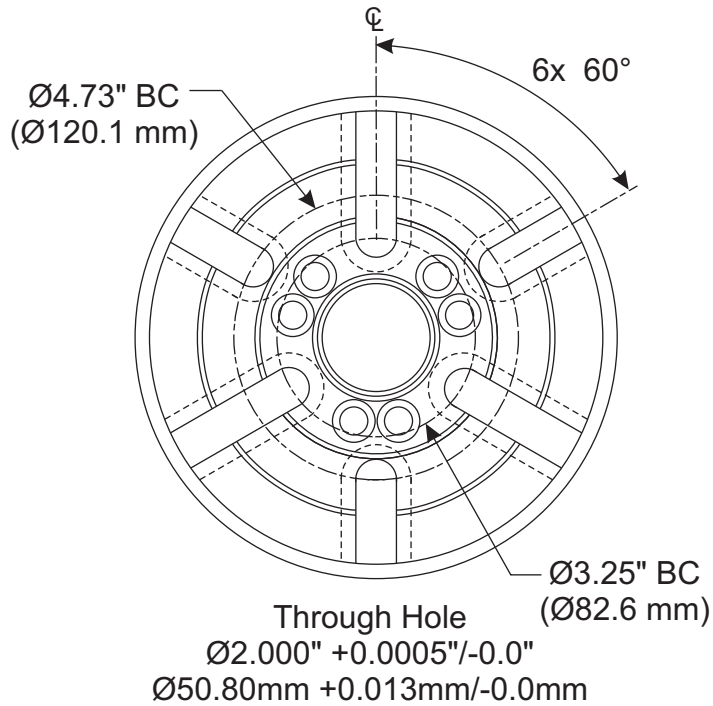

Bottom View

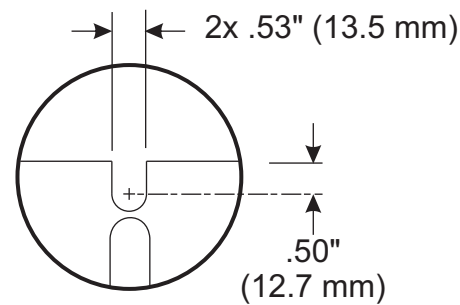
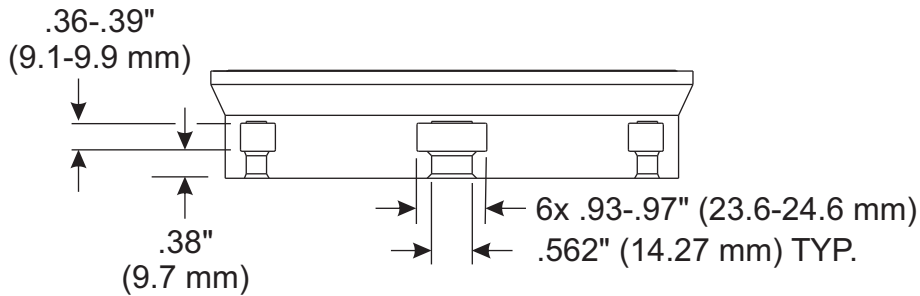

Front and Rear Tie-Down Slots

For mounting instructions, see Rotary Operator's Manual.

Go to www.haascnc.com for further rotary specifications.

