

# HRT210-2 Machine Layout Drawing

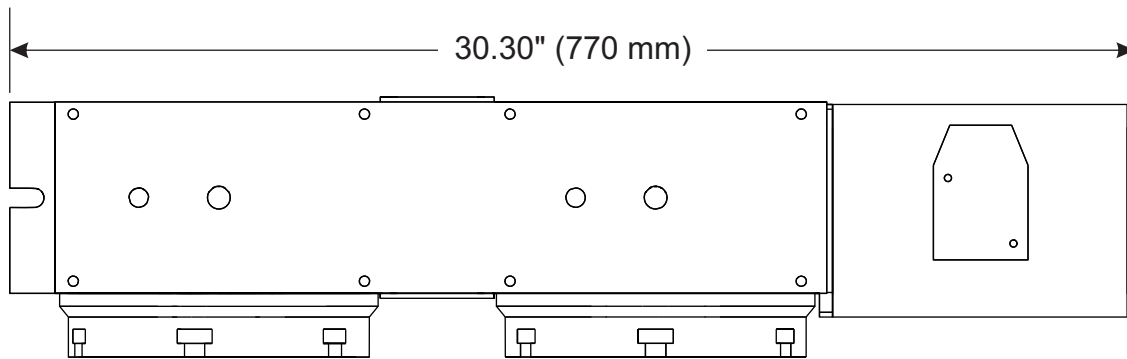

**Top View**

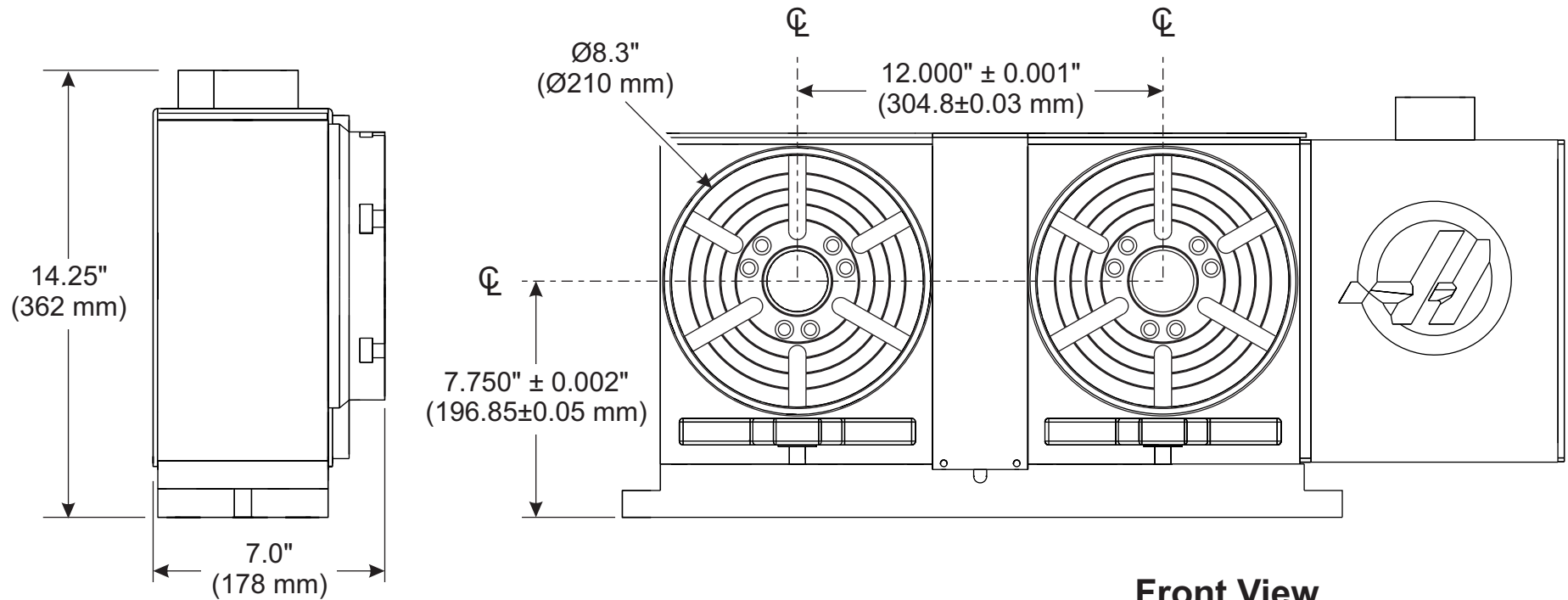
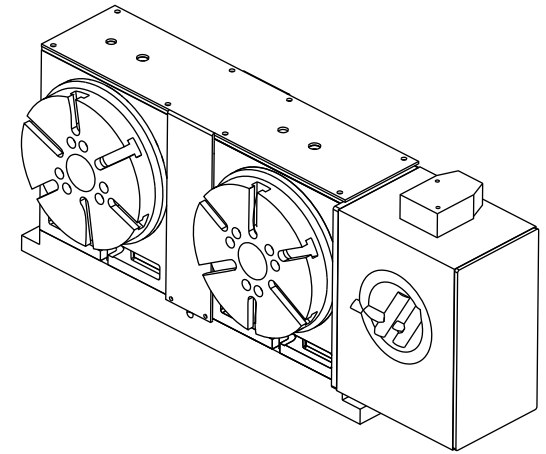

**Front View**



# HRT210-2 Machine Layout Drawing

## HRT210-2 Platter Dimensions

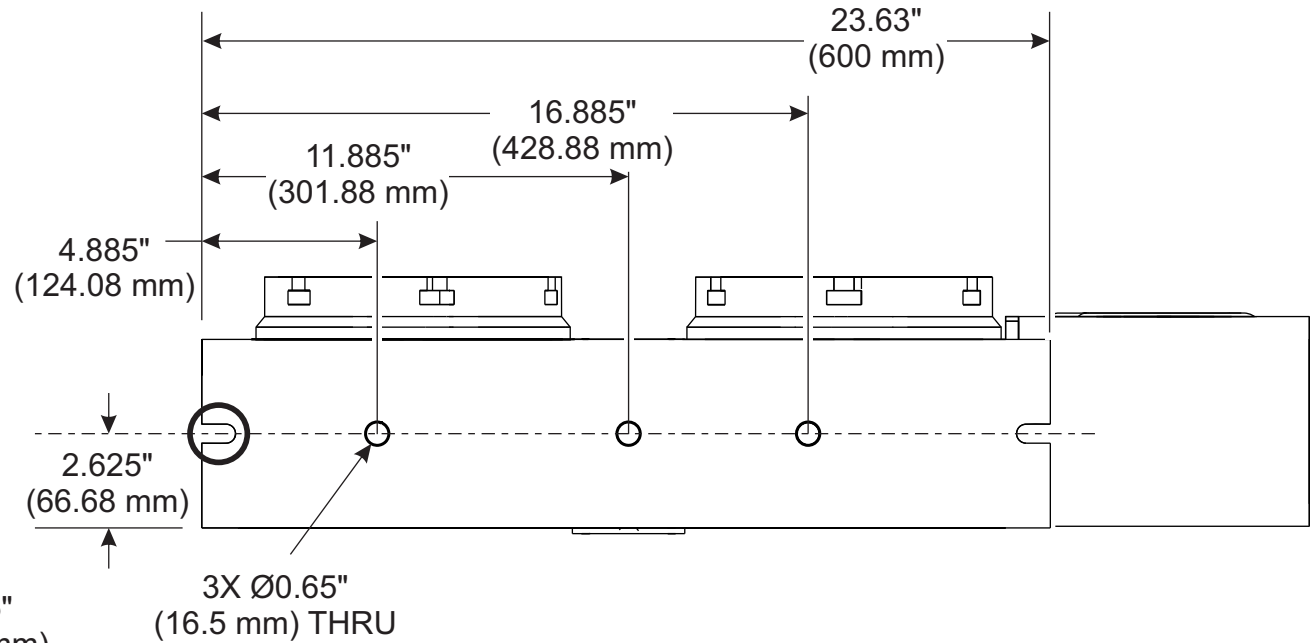
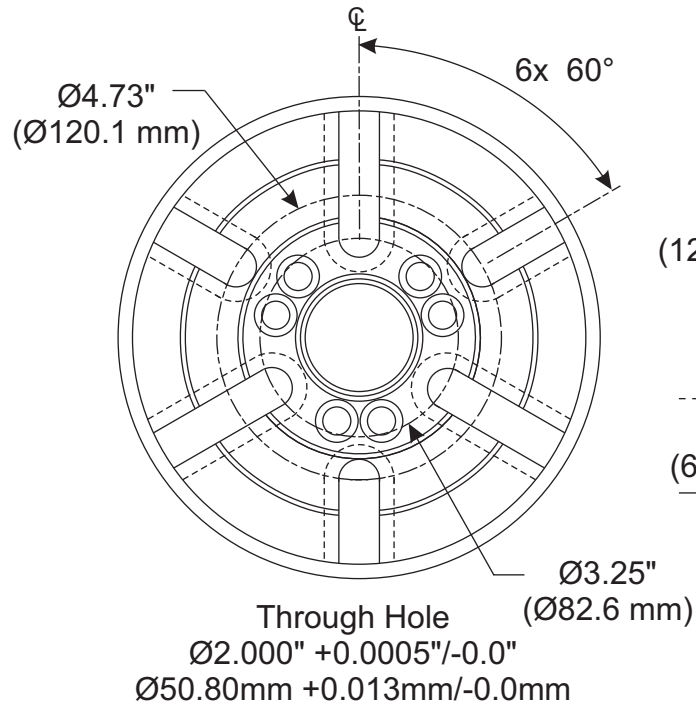

## Bottom View

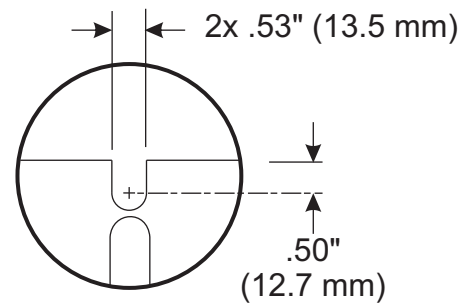
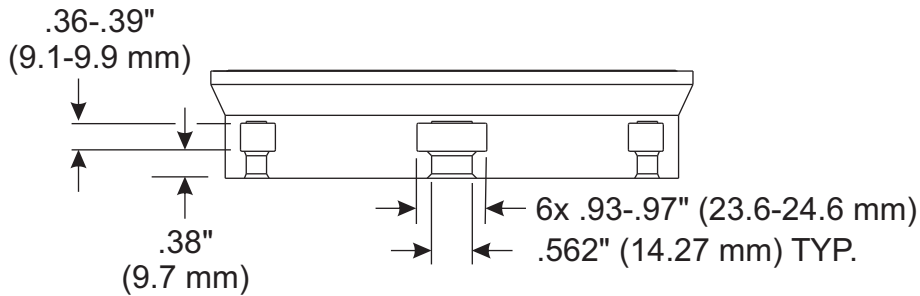

Front and Rear Tie-Down Slots

For mounting instructions, see Rotary Operator's Manual.

Go to [www.haascnc.com](http://www.haascnc.com) for further rotary specifications.

