

All dimensions based on stackup of sheetmetal, subject to variation of 1/2" (13 mm)

*Due to continual product improvements, machine dimensions are subject to change without notice.

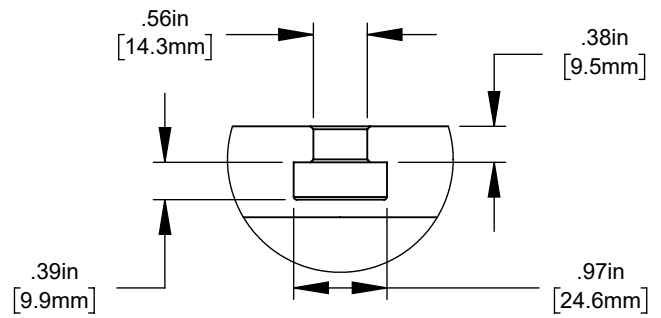
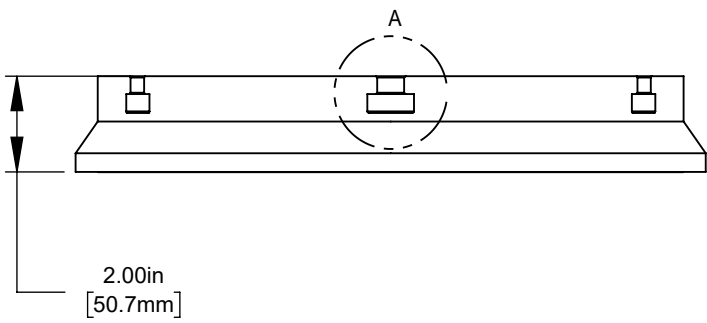
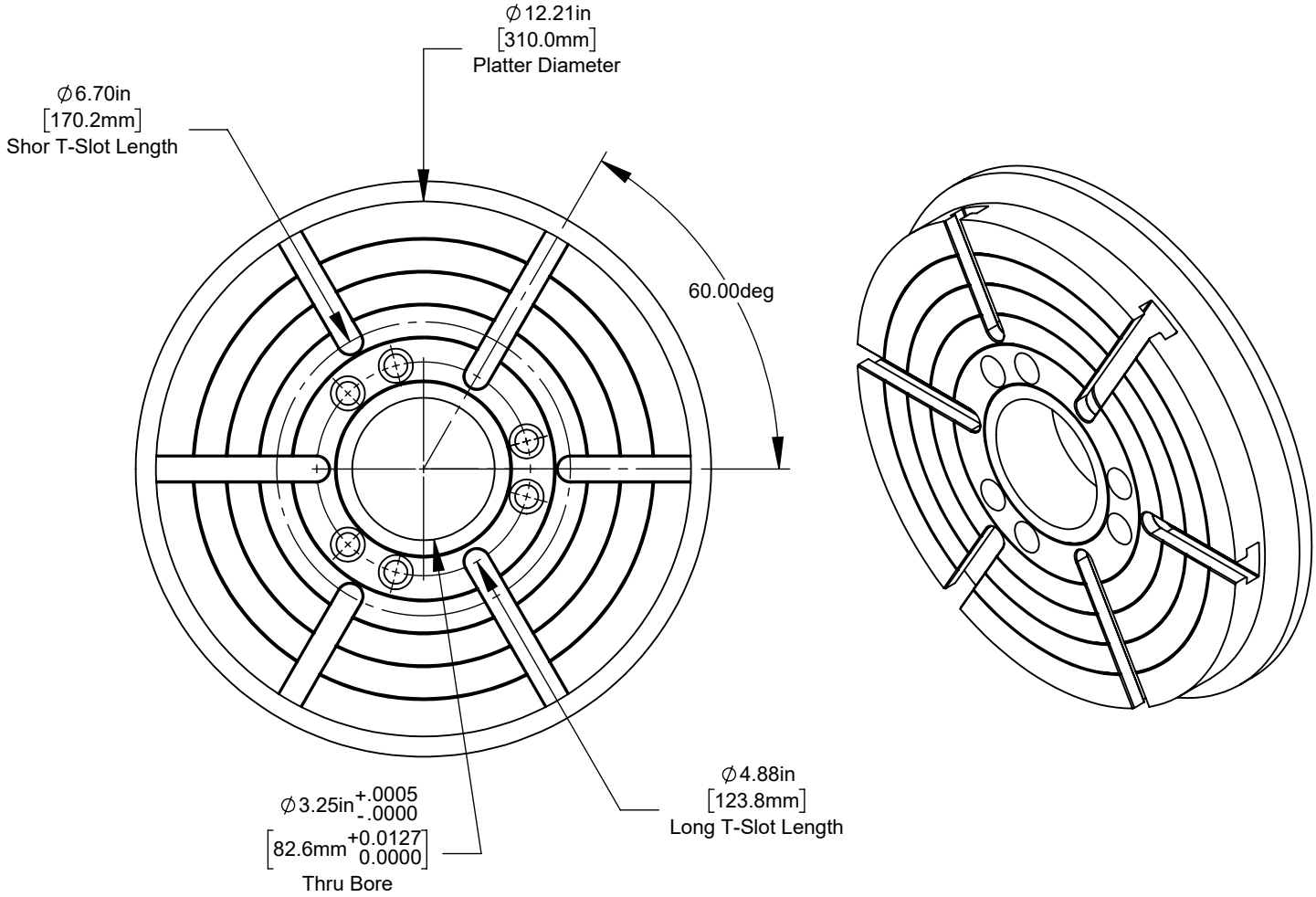

DETAIL A
SCALE 1 : 2

*Due to continual product improvements, machine dimensions are subject to change without notice.